

Before You Begin

- Do not modify the motor in any way, except as described herein.
- If any parts are missing or damaged, call AeroTech at 435-865-7100.
- Use only AeroTech RMS reload kits to refurbish an RMS motor.
- Do not interchange parts from different reload kits.
- Do not reuse any parts of the RMS reload kit.
- Save the reload kit plastic bag for the used reload kit parts. Dispose of bag and parts properly.

Package Contents

RMS-Plus reload kit components
Complete reload delay kit
Igniter & ejection charge kit

Hardware and Supplies Required

RMS 38mm aft closure
RMS 38mm case (see RMS-Plus packaging tube label for size)
RMS 38mm standard forward closure **OR** 38mm reload adapter system (if needed; refer to RAS instructions)
38mm forward seal disk
RMS delay drilling tool (RDDT)
Synco™ Super Lube™ or other grease
Hobby knife or scissors
Wet wipes or damp paper towels

Preparation for Flight

1. Remove the supplied FirstFire™ igniter from the cardboard tube and straighten the leads.
2. Strip 1/2"-1" of insulation from the end of the leads.
3. Insert the black-coated end of the igniter through the nozzle opening and push it completely into the motor core, until the coated end is touching the time delay element in the modular bulkhead.
4. Using a hobby knife or scissors, cut a corner off the supplied nozzle cap to produce a vent hole in the cap about 1/16"-1/8" wide.
5. Press the open end of the nozzle cap over the exposed nozzle extension to hold the igniter firmly in place.
6. Install the motor into the rocket's motor mount tube. Ensure that the motor is securely retained in the rocket by using positive mechanical means to prevent it from being ejected during recovery system deployment.
7. Prepare the rocket's recovery system and then launch the rocket in accordance with the National Association of Rocketry (NAR) and/or Tripoli Rocketry Association (TRA) Safety Codes.

Post-Recovery Cleanup

NOTE: Perform motor clean-up as soon as possible after motor firing. Propellant and smoke charge residues become difficult to remove after 24 hours and can lead to corrosion of the metal parts. Place the spent motor components in the reload kit plastic bag and dispose of properly.

1. After the motor has cooled down, unthread and remove the aft and forward closures.

AeroTech Division
RCS Rocket Motor Components, Inc.
Cedar City, UT 84721
www.aerotech-rocketry.com

Post-Recovery Cleanup (cont'd)

2. Remove the spent components from the casing by pushing on the nozzle end and discard. Using wet wipes or damp paper towels, wipe the inside of the casing and all surfaces of the aft and forward closures and forward seal disk to remove all propellant residue. **DO NOT DISCARD THE FORWARD SEAL DISK!**
3. Apply a light coat of grease to all threads and the inside of the motor case. Reassemble metal parts and store motor in a dry place.

First Aid

Do not ignite an AeroTech motor indoors. Do not breath fumes from the rocket motor exhaust. For a minor burn, apply a burn ointment. For a severe burn, immerse the burned area in ice water at once and see a physician as quickly as possible. In the unlikely event of oral ingestion of the propellant, induce vomiting and see a physician as quickly as possible. The composite propellant used in AeroTech reload kits consists primarily of Ammonium Perchlorate and a rubber-like plastic elastomer. Redline™ propellant also contains Strontium Nitrate, and Mojave Green™ propellant contains Barium Nitrate.

Disposal

Pack assembled motor firmly in a hole in the ground so that only the nozzle is exposed, away from people, animals, buildings and flammable materials. Ignite motor electrically from a distance of 30 feet or more. Propellant, delay and ejection charge (if installed) will burn until consumed. Wait until the motor has cooled off before disassembly and cleanup.

Fire Safety

Tests show that the pyrotechnic components of RMS™ reload kits will not explode in fires and normally will not ignite unless subjected to direct flame and then will burn slowly. Use water to fight any fires in which AeroTech RMS™ reload kit pyrotechnic components may become involved: Direct the water at the AeroTech RMS™ reload kit pyrotechnic components to keep them below their 550 deg. F autoignition temperature. Foam and carbon dioxide fire extinguishers will NOT extinguish burning propellants of the type used in RMS™ reload kit pyrotechnic components. Keep reload kit pyrotechnic components away from flames, sources of heat and flammable materials.

Disclaimer and Warranty

NOTICE: As we cannot control the storage and use of our products, once sold we cannot assume any responsibility for product storage, transportation or usage. RCS shall not be held responsible for any personal injury or property damage resulting from the handling, storage or use of our product. The buyer assumes all risks and liabilities therefrom and accepts and uses AeroTech/RCS products on these conditions. No warranty either expressed or implied is made regarding AeroTech/RCS products, except for replacement or repair, at RCS's option, of those products which are proven to be defective in manufacture within one year from the date of original purchase. For repair or replacement under this warranty, please contact RCS. Proof of purchase will be required. Note: Your state may provide additional rights not covered by this warranty.

Certified by the Tripoli Rocketry Association
Instructions P/N 21055 Rev. 5/12/16
Made in U.S.A.

©2015-2016 RCS Rocket Motor Components, Inc., All rights reserved



RMS-PLUS™ HIGH-POWER Reloadable Motor System™

Rocket Motor Reload Kit With RMS-Plus Delay Assembly & Operation Instructions

For RMS-38/480-1320 Motor Hardware

DO NOT OPEN RELOAD KIT UNTIL READY TO USE

Note: Motor designation and complete performance specifications (including sample time-thrust curve) are printed on the RMS-Plus packaging tube.

WARNING-FLAMMABLE: READ INSTRUCTIONS BEFORE USE. Use RMS reload kits only in accordance with instructions. Sale to persons under 18 years of age prohibited by federal law. For use only by certified users 18 years of age or older. Ignite by electrical means only. Do not smoke when loading RMS motors or use in the vicinity of open flames. **CAUTION:** Keep out of reach of children. Metalstorm™ propellants produce showers of hot sparks. Clear launch area of all combustible material for at least a 75 foot diameter radius around launcher. Follow NAR & TRA safety codes at all times. Motor hot after firing.

Setting the Time Delay

Note: If you want to use the longest (as-supplied) time delay, do not use the RMS delay drilling tool and instead proceed with general motor assembly (inside pages).

1. **WARNING:** Do not smoke and ensure that there are no open flames or heat sources nearby when setting the time delay. Assemble the AeroTech RMS delay drilling tool with the desired amount of delay time removal (i.e., the - 4 or - 8 seconds removal marked on the tool label) facing the exposed drill bit and delay grain.

2. **Optional:** Place the washer between the drill knob and the tool if you want to remove 2 seconds less than the value printed on the tool (i.e., - 2 or - 6 seconds removal).

3. Place the delay grain into the cavity in the appropriate end of the tool, hold the tool and grain firmly together and turn the drill knob several times clockwise until the drill knob sits flush against the drill tool body.

4. Remove the tool and shake out the shavings from the tool and delay grain. Dispose of the shavings by burning with a safe method and in a safe location.



RMS-Plus™ 38/480-1320 Assembly Drawing and Notes

Phenolic liner, forward seal disk

NOTE: THE DRAWING SHOWN BELOW IS A GENERIC REPRESENTATION OF THE ACTUAL MOTOR. NOZZLE SIZE, NUMBER AND SIZE OF PROPELLANT GRAINS AND LENGTH OF DELAY GRAIN MAY BE DIFFERENT.

ITEM	DESCRIPTION	QTY	ITEM	DESCRIPTION	QTY
1	NOZZLE CAP	1	10	FORWARD O-RING	1
2	AFT CLOSURE	1	11	AFT DELAY SPACER	1 OR NONE
3	NOZZLE	1	12	DELAY GRAIN	1
4	AFT O-RING	1	13	DELAY INSULATOR	1
5	AFT INSULATOR	1	14	FORWARD CLOSURE	1
6	LINER	1	15	EJECTION CHARGE	AR
7	CASE	1	16	EJECTION CHARGE CAP	1
8	PROPELLANT GRAINS	VARIES	17	DELAY O-RING	1
9	FORWARD SEAL DISK	1	18	FORWARD DELAY SPACER	1
			19	FORWARD SEAL DISK O-RING	1

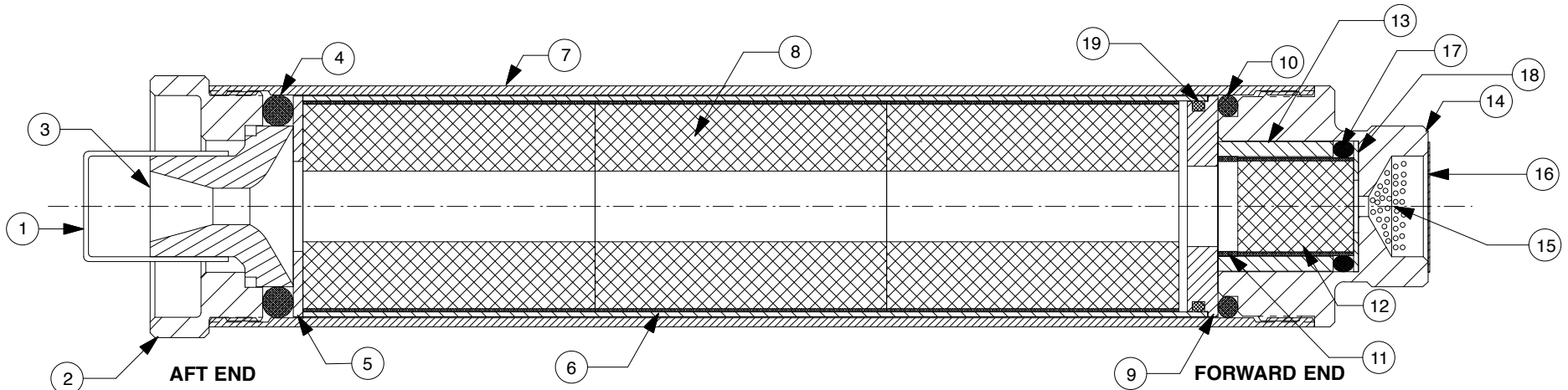

General Motor Assembly Instructions (numbers refer to item numbers on drawing):

1. Lightly grease o-rings (4, 10, 17 & 19) and case & closure threads (2, 7 & 14)
2. Install forward seal disk o-ring (19) into groove on forward seal disk (9).
3. Install forward seal disk assembly (19 & 9) into one end of liner (6).
4. Insert propellant grains (8) into liner (6), with grain spacer o-rings if included (19) between each grain, then push liner assembly into case (7) until recessed equally from ends of case.
5. Install forward o-ring (10) into the end of case (7) with the forward seal disk (9).
6. Trim time delay grain (12) if desired, using AeroTech RMS delay drilling tool (RDDT). **NOTE:** Drilled end of delay grain faces propellant.
7. Assemble time delay components into the forward closure (14) as shown and per the enclosed Complete Reload Delay Kit (CRDK) instructions.
8. Thread the assembled forward closure (14) into the end of the case (7) with the forward seal disk (9) and forward o-ring (10) until seated.
9. Install aft insulator (5), aft o-ring (4), nozzle (3) and aft closure (2) into open end of case (7) until seated.
10. Dispense ejection charge (15) into forward closure (14) and seal end with ejection charge cap (16).

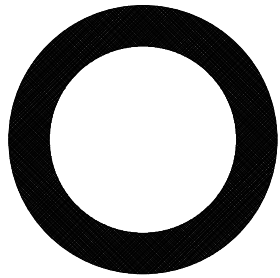

Aft O-ring (4)
1-3/8" x 3/16" 318

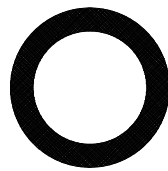

Delay O-ring (17)
21mm x 3mm
AeroTech P/N 00001

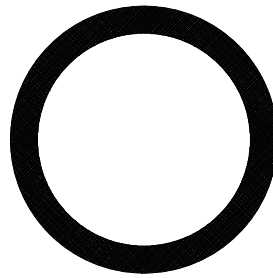

Forward O-ring (10)
1-3/8" x 1/8" 216

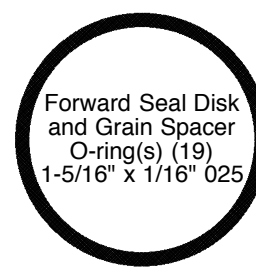

Forward Seal Disk
and Grain Spacer
O-ring(s) (19)
1-5/16" x 1/16" 025

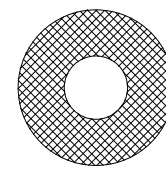

Forward Delay
Spacer (18)

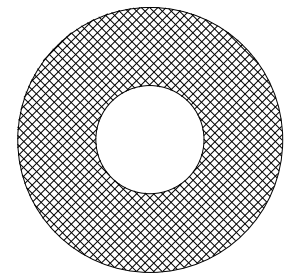

Aft Insulator (5)